

Selection - PR-AC ATX 456 T

Product Code	7PA4606
Requested Air Volume	4 001 m ³ /h
Requested Pressure	61 Pa
Air Volume	3 990 m ³ /h
Static Pressure	61 Pa
Total Pressure	90 Pa
Velocity Pressure	29,6 Pa
Outlet Velocity	6,97 m/s
SFP	0,10 W/l/s
Fan Total Efficiency	87,4 %
Fan Static Efficiency	58,7 %
Air Properties	1,22kg/m ³ / 15°C/ 0m/ 50% RH
Motor Input Power	0,115 kW
Temperature Range	-20°C 40°C

Construction Settings

Arrangement	4
Discharge	LG-270
Motor Position	D

Motor Selection

Electrical Supply	400/3/50
Motor Rating	0.37 kW
Enclosure/Class	55 / F
Poles number	6
Motor Speed	910 rpm
Full Load Current	1.37 A

ERP Information

ERP Compliance	Exempt
Type	
Regulation	-
Category of measure	-

Fan Performance

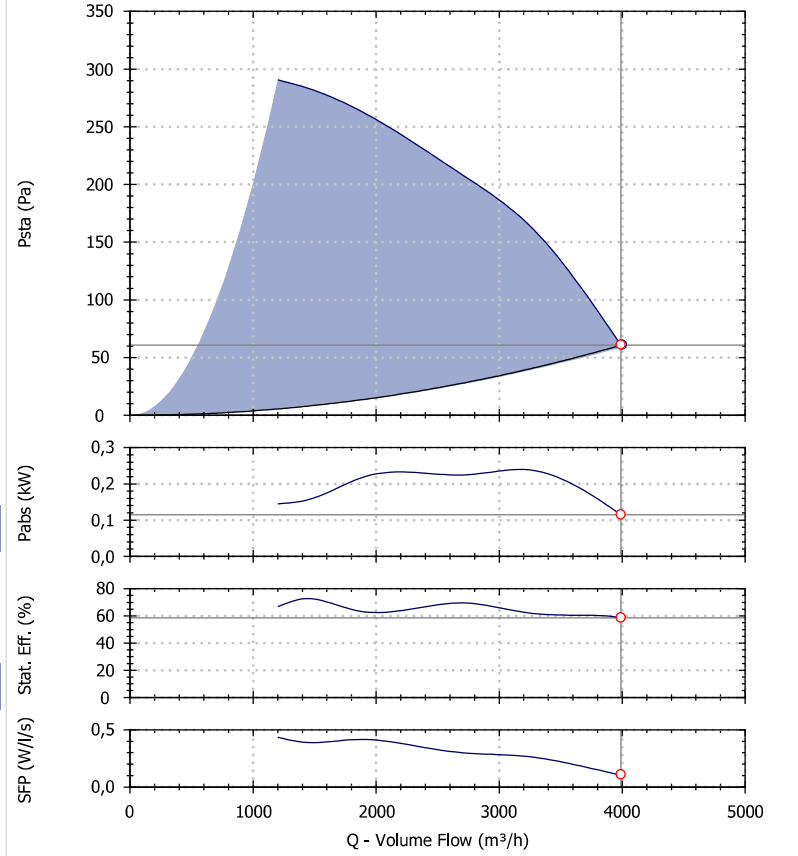

Performances refers to Maico Italia measures and may vary according to the installation type.

Sound Performance

Hz	63	125	250	500	1k	2k	4k	8k	Overall
Lw	58	63	58	56	55	50	42	34	66
Lw(A)	32	47	49	53	55	51	43	33	59
LpA @ 3m	11	26	29	32	34	31	22	12	38

Sounds spectra refers to Maico Italia measures performed in our laboratories. The values provided are just indicative of the situation and Maico Italia declines every responsibility in case different levels measured by our customers as the installation types and the environmental variables may increase/decrease these values.

Drawing and Dimensions - PR-AC ATX 456 T

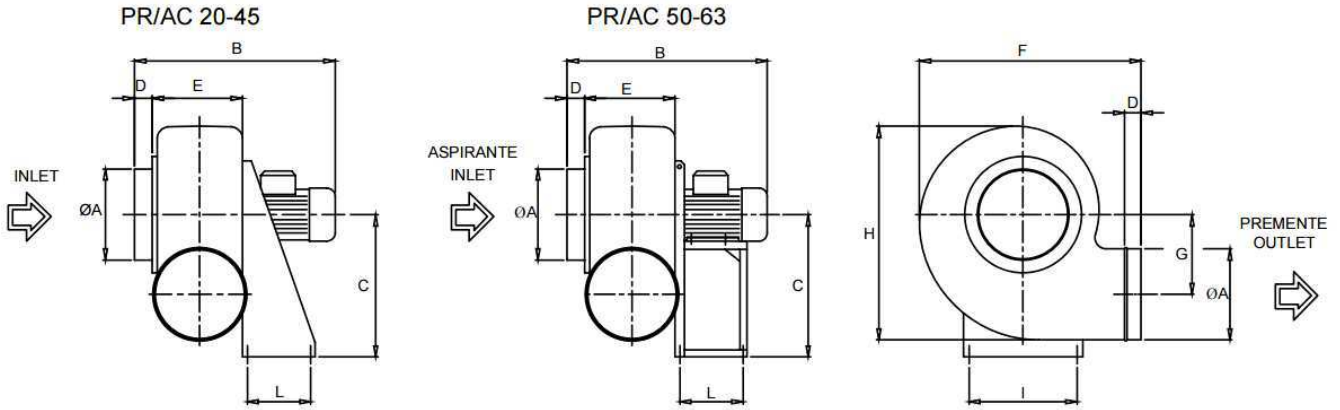

Key	B	C	D	E	F	G	H	I	kg	L	M	N	O	OA
Value [mm]	630	550	40	265	730	324	870	370	46	170	150	405	170	355

Drawings are indicative of the size of the selected fan. These dimensions may vary, even without any explicit advice. To have more accurate information contact your local agency.

Electric Wire Connections

