

AC axial fan

Series 3000 92 x 92 x 38

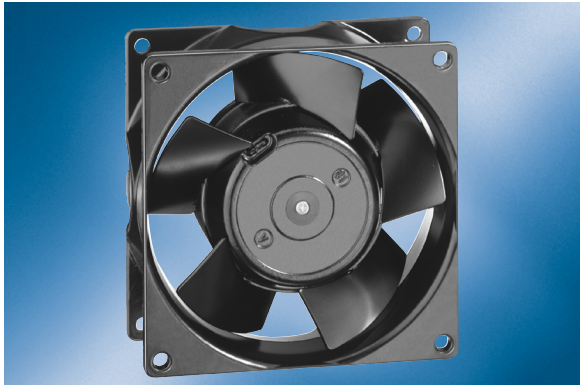

- **General description:** AC fan with internal rotor shaded-pole motor.
- **Impeller material:** Metal
- **Housing material:** Metal

Nominal data		Voltage	Frequency	Air flow	Speed	Power consumption	Sound level	Sound pressure level	Ambient temperature	L10 service life at 40 °C	L10 service life at max. temp.	Weight
Type	Motor	VAC	Hz	m³/h	1/min	W	Bel	dB(A)	°C	h	h	kg
3656	--	230	50	75	2700	12.0	4.9	37	-40 .. 75	52500	22500	0.420

Subject to modification

Characteristic: Pressure over air flow

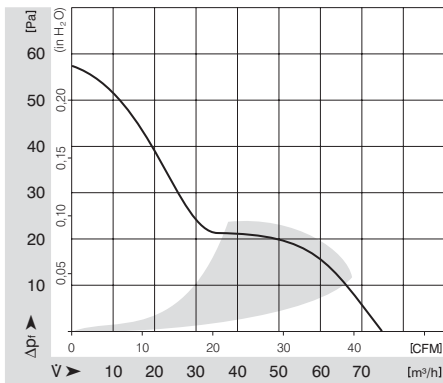

Specific drawing

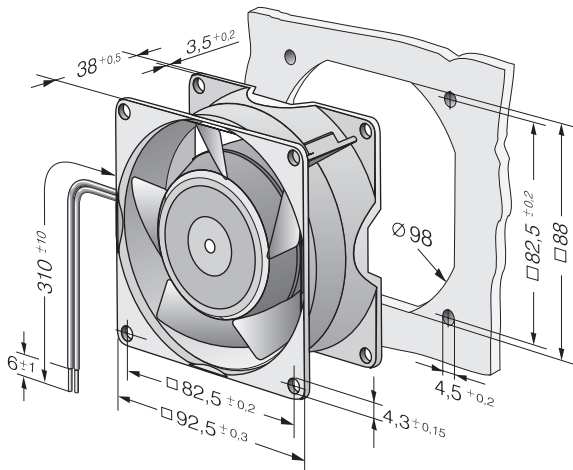

AC axial fan

Series 3000 92 x 92 x 38

Technical description

- **General description:** AC fan with internal rotor shaded-pole motor.
- **Housing material:** Metal
- **Direction of rotation:** Right, looking at rotor
- **Electrical connection:** 2 single strands AWG 18
- **Approvals:** VDE, CSA, UL, CE
- **Impeller material:** Metal
- **Bearings:** Ball bearings
- **Direction of air flow:** Air exhaust over bars
- **Motor protection:** Protected from overload using impedance protection

Contact

ebm-papst St. Georgen GmbH & Co. KG

Hermann-Papst-Straße 1
D-78112 St. Georgen
Phone +49 (0) 7724 / 81-0
Fax +49 (0) 7724 / 81-1309
info2@de.ebmpapst.com
www.ebmpapst.com