

Selection - FCP 404 T 5400 0,55kW

Product Code	1FC1400
Requested Air Volume	5 390 m ³ /h
Requested Pressure	5,63 Pa
Air Volume	5 393 m ³ /h
Static Pressure	5,63 Pa
Total Pressure	92 Pa
Velocity Pressure	86 Pa
Outlet Velocity	11,89 m/s
SFP	0,38 W/l/s
Fan Total Efficiency	35,5 %
Fan Static Efficiency	2,2 %
Air Properties	1,22kg/m ³ / 15°C/ 0m/ 50% RH
Fan Absorbed Power	0,388 kW
Temperature Range	-20°C +80°C
Fan Energy Index (FEI)	0,74

Motor Selection

Electrical Supply	400/3/50
Motor Rating	0.55 kW
Enclosure/Class	55 / F
Frame Size	80
Poles number	4
Motor Speed	1400 rpm
Full Load Current	1.6 A

Fan Performance

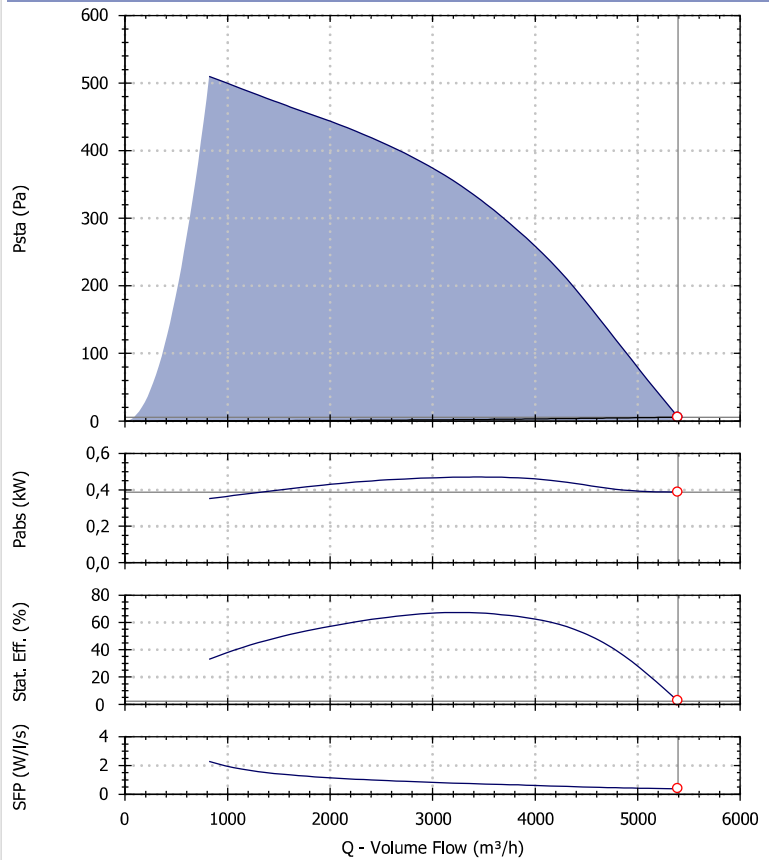

Performances refers to Maico Italia measures and may vary according to the installation type.

Sound Performance

Hz	63	125	250	500	1k	2k	4k	8k	Overall
Lw	48	74	77	79	79	74	76	66	85
Lw(A)	22	58	68	76	79	75	77	65	83
LpA @ 3m	1	37	48	55	58	55	56	44	63

Sounds spectra refers to Maico Italia measures performed in our laboratories. The values provided are just indicative of the situation and Maico Italia declines every responsibility in case different levels measured by our customers as the installation types and the environmental variables may increase/decrease these values.

Drawing and Dimensions - FCP 404 T 5400 0,55kW

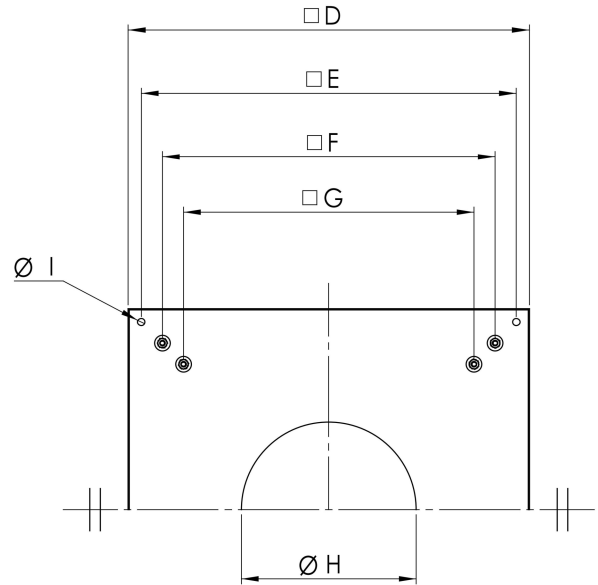
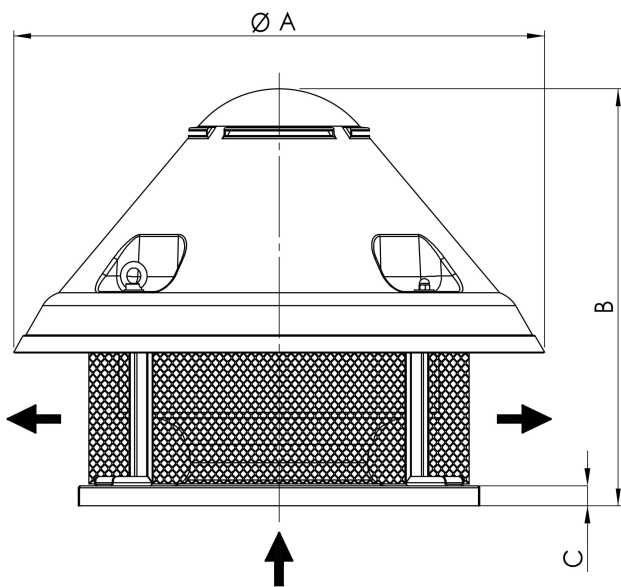

Key	(Kg)	B	C	D	E	F	G	OA	OH	OI
Value [mm]	45	670	274	650	600	521	471	910	269	12

Drawings are indicative of the size of the selected fan. These dimensions may vary, even without any explicit advice. To have more accurate information contact your local agency.

Electric Wire Connections

230 V/3 Ph/50 Hz

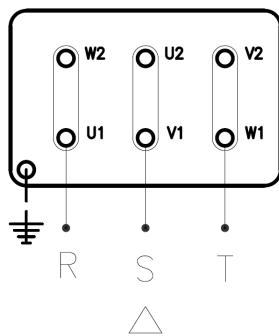

400 V/3 Ph/50 Hz

