

Selection - FC 406 T

Product Code	1FC4168
Requested Air Volume	3 055 m ³ /h
Requested Pressure	2,74 Pa
Air Volume	3 060 m ³ /h
Static Pressure	2,75 Pa
Total Pressure	30,7 Pa
Velocity Pressure	27,9 Pa
Outlet Velocity	6,76 m/s
SFP	0,12 W/l/s
Fan Total Efficiency	25,1%
Fan Static Efficiency	2,3 %
Air Properties	1,22kg/m ³ / 15°C/ 0m/ 50% RH
Fan Absorbed Power	0,104 kW
Temperature Range	+100°C
Fan Energy Index (FEI)	5,83

Motor Selection

Electrical Supply	400/3/50
Motor Rating	0.18 kW
Enclosure/Class	55 / F
Frame Size	71
Poles number	6
Motor Speed	960 rpm
Full Load Current	0.80 A

ERP Information

ERP Compliance	Exempt
Type	-
Regulation	-
Category of measure	-

Fan Performance

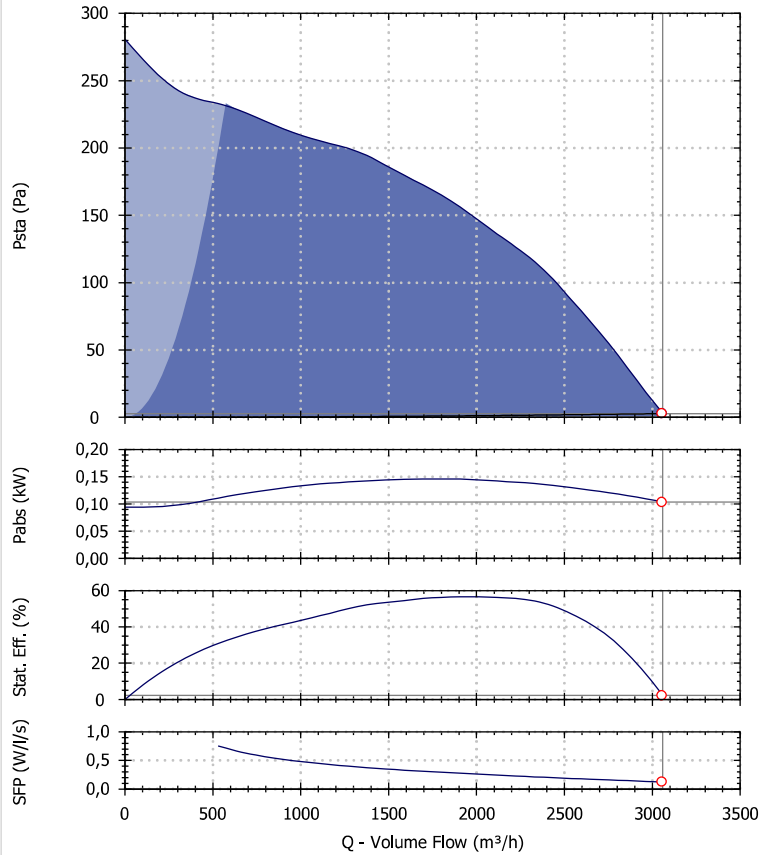

Performances refers to Maico Italia measures and may vary according to the installation type.

Sound Performance

Hz	63	125	250	500	1k	2k	4k	8k	Overall
Lw	42	56	63	65	66	63	60	48	71
Lw(A)	16	40	54	62	66	64	61	47	70
LpA @ 3m	-	19	34	41	45	44	40	26	49

Sounds spectra refers to Maico Italia measures performed in our laboratories. The values provided are just indicative of the situation and Maico Italia declines every responsibility in case different levels measured by our customers as the installation types and the environmental variables may increase/decrease these values.

Drawing and Dimensions - FC 406 T

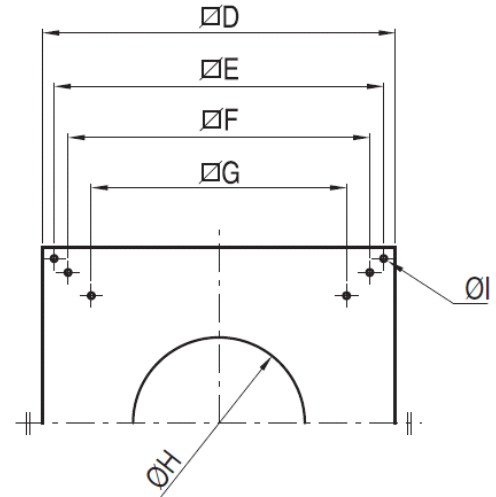
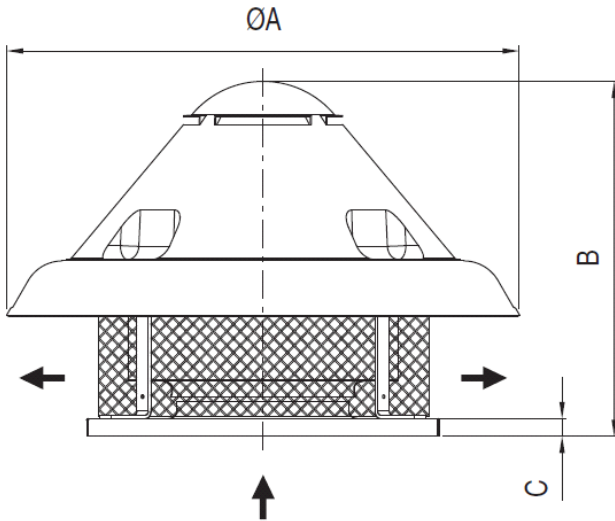

Key	ΦA	B	C	D	E	F	G	ΦH	ΦI	kg
Value [mm]	900	640	38	650	600	530	471	296	12	30

Drawings are indicative of the size of the selected fan. These dimensions may vary, even without any explicit advice. To have more accurate information contact your local agency.

Electric Wire Connections

230 V/3 Ph/50 Hz

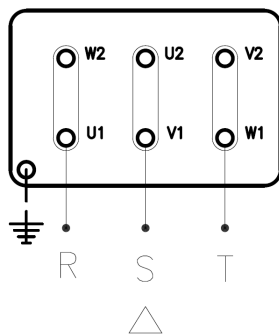

400 V/3 Ph/50 Hz

