

# AC axial fan

Series 4000 N 119 x 119 x 38



- **General description:** AC fan with external rotor shaded-pole motor.
- **Impeller material:** Metal
- **Housing material:** Metal

Nominal data		Voltage	Frequency	Air flow	Speed	Power consumption	Sound level	Sound pressure level	Ambient temperature	L10 service life at 40 °C	L10 service life at max. temp.	Weight
Type	Motor	VAC	Hz	m³/h	1/min	W	Bel	dB(A)	°C	h	h	kg
4650 N	--	230	50	160	2650	19.0	5.4	46	-10 .. 55	37500	27500	0.550

Subject to modification

## Characteristic: Pressure over air flow

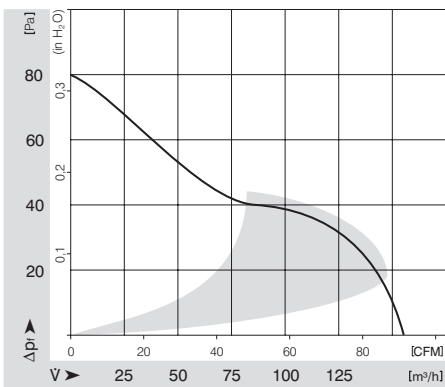

# AC axial fan

Series 4000 N 119 x 119 x 38

## Specific drawing

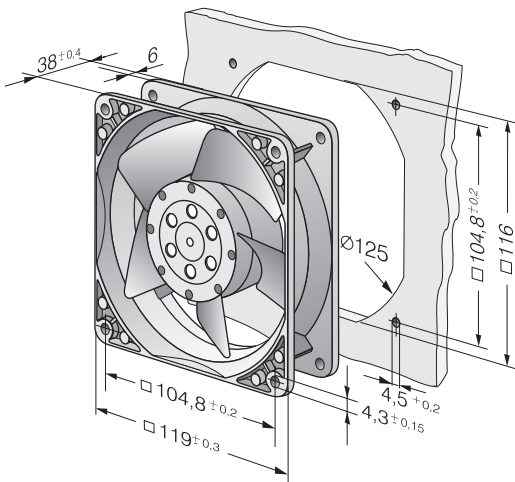

## Technical description

- **General description:** AC fan with external rotor shaded-pole motor.
- **Housing material:** Metal
- **Direction of rotation:** Right, looking at rotor
- **Electrical connection:** 2 flat plugs 3.0 x 0.5 mm. Housing with grounding lug for screw M4 and UNC.
- **Approvals:** VDE, CSA, UL, CE

- **Impeller material:** Metal
- **Bearings:** Sintec sleeve bearing system
- **Direction of air flow:** Inlet over bars
- **Motor protection:** Protected from overload using impedance protection
- **Option:** Variants optionally available with reinforced mounting flanges and customizable single-strand wiring.

## Contact

### ebm-papst St. Georgen GmbH & Co. KG

Hermann-Papst-Straße 1  
D-78112 St. Georgen  
Phone +49 (0) 7724 / 81-0  
Fax +49 (0) 7724 / 81-1309  
info2@de.ebmpapst.com  
www.ebmpapst.com