

AC axial fan



- **Impeller material:** Sheet steel (welded to the rotor and stove-enameled in black)
- **Housing material:** Die-cast aluminum
- **Bearings:** Ball bearings

Nominal data

Type	Motor	Voltage 1 - VAC	Frequency Hz	Air flow m³/h	Speed 1/min	Power consumption W	Sound pressure level dB(A)	Operative range 50Hz Pa	Ambient temperature 50Hz °C	Weight kg
W2E143AB0901	M2E052BF	230	50	420	2800	26	54	0 .. 170	-25 .. 60	1.0

Subject to modification

Characteristic: Pressure over air flow at 50Hz

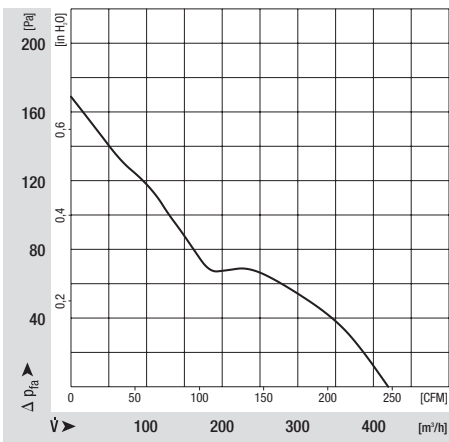

AC axial fan

Specific drawing

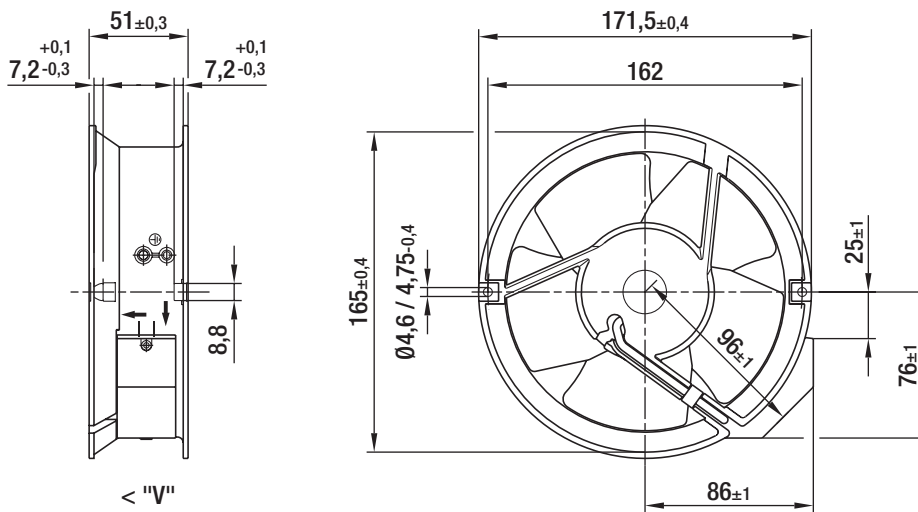

Technical description

- **Impeller material:** Sheet steel (welded to the rotor and stove-enameled in black)
- **Bearings:** Ball bearings
- **Direction of air flow:** "V", exhaust over braces
- **Operating mode:** S1
- **Protection class:** I
- **Housing material:** Die-cast aluminum
- **Direction of rotation:** Left, looking at rotor
- **Electrical connection:** Flat plugs 2.8 x 0.5 mm, built-in operating capacitor
- **Insulation class:** "B"
- **Approvals:** VDE, CSA, UL, CE

Contact

ebm-papst Mulfingen GmbH & Co. KG
Bachmühle 2
D-74673 Mulfingen
Phone +49 (0) 79 38 / 81-0
Fax +49 (0) 79 38 / 81-110
info1@de.ebmpapst.com
www.ebmpapst.com