

Selection - PR-AC 454 T

Product Code	7PA4603
Requested Air Volume	5 953 m ³ /h
Requested Pressure	144 Pa
Air Volume	5 954 m ³ /h
Static Pressure	144 Pa
Total Pressure	210 Pa
Velocity Pressure	66 Pa
Outlet Velocity	10,40 m/s
SFP	0,24 W/l/s
Fan Total Efficiency	86,2 %
Fan Static Efficiency	59,1 %
Air Properties	1,22kg/m ³ / 15°C/ 0m/ 50% RH
Motor Input Power	0,402 kW
Temperature Range	-15°C +70°C

Construction Settings

Arrangement	4
Discharge	LG-270
Motor Position	D

Motor Selection

Electrical Supply	400/3/50
Motor Rating	1.10 kW
Enclosure/Class	55 / F
Poles number	4
Motor Speed	1400 rpm
Full Load Current	2.70 A

ERP Information

ERP Compliance	Exempt
Type	
Regulation	-
Category of measure	-

Fan Performance

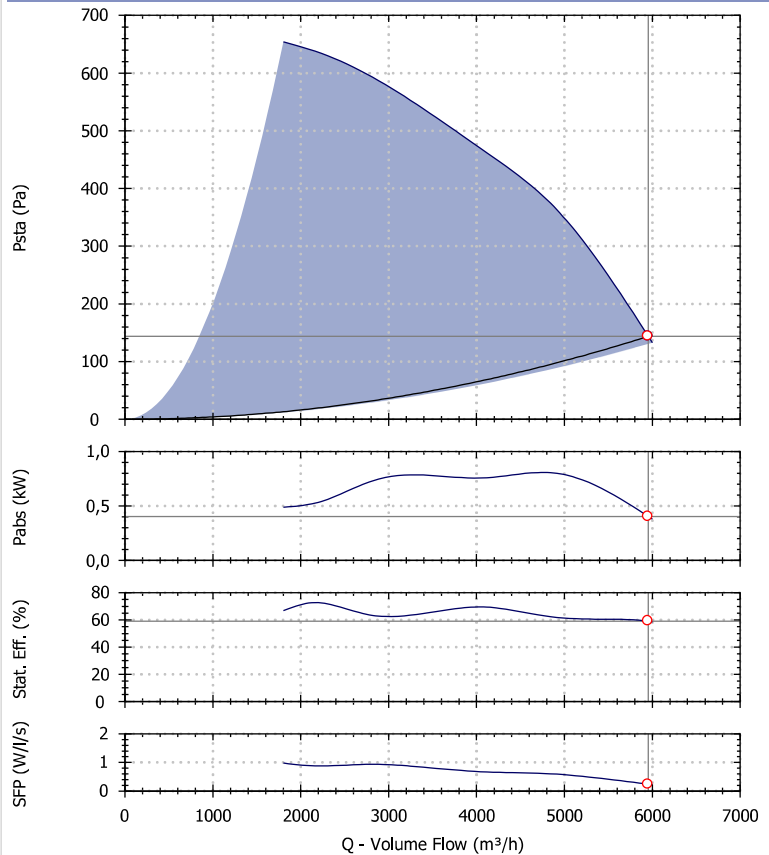

Performances refers to Maico Italia measures and may vary according to the installation type.

Sound Performance

Hz	63	125	250	500	1k	2k	4k	8k	Overall
Lw	67	69	70	65	64	59	51	43	75
Lw(A)	41	53	61	62	64	60	52	42	68
LpA @ 3m	20	32	41	41	43	40	31	21	48

Sounds spectra refers to Maico Italia measures performed in our laboratories. The values provided are just indicative of the situation and Maico Italia declines every responsibility in case different levels measured by our customers as the installation types and the environmental variables may increase/decrease these values.

Drawing and Dimensions - PR-AC 454 T

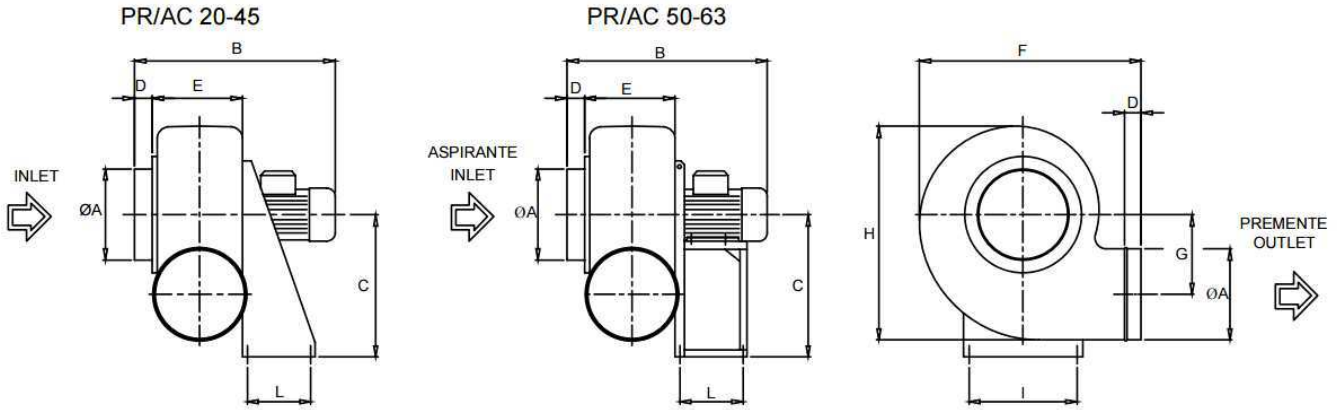

Key	B	C	D	E	F	G	H	I	kg	L	M	N	O	OA
Value [mm]	630	550	40	265	730	324	870	370	46	170	150	405	170	355

Drawings are indicative of the size of the selected fan. These dimensions may vary, even without any explicit advice. To have more accurate information contact your local agency.

Electric Wire Connections

