

Selection - PR-AC 312 T

Product Code	7PA3227
Requested Air Volume	4 647 m ³ /h
Requested Pressure	271 Pa
Air Volume	4 681 m ³ /h
Static Pressure	275 Pa
Total Pressure	445 Pa
Velocity Pressure	170 Pa
Outlet Velocity	16,69 m/s
SFP	0,93 W/l/s
Fan Total Efficiency	47,8 %
Fan Static Efficiency	29,5 %
Air Properties	1,22kg/m ³ / 15°C/ 0m/ 50% RH
Motor Input Power	1,21 kW
Temperature Range	-15°C +70°C

Construction Settings

Arrangement	4
Discharge	LG-270
Motor Position	D

Motor Selection

Electrical Supply	400/3/50
Motor Rating	1.50 kW
Enclosure/Class	55 / F
Poles number	2
Motor Speed	2830 rpm
Full Load Current	3.40 A

ERP Information

ERP Compliance	Exempt
Type	
Regulation	-
Category of measure	-

Fan Performance

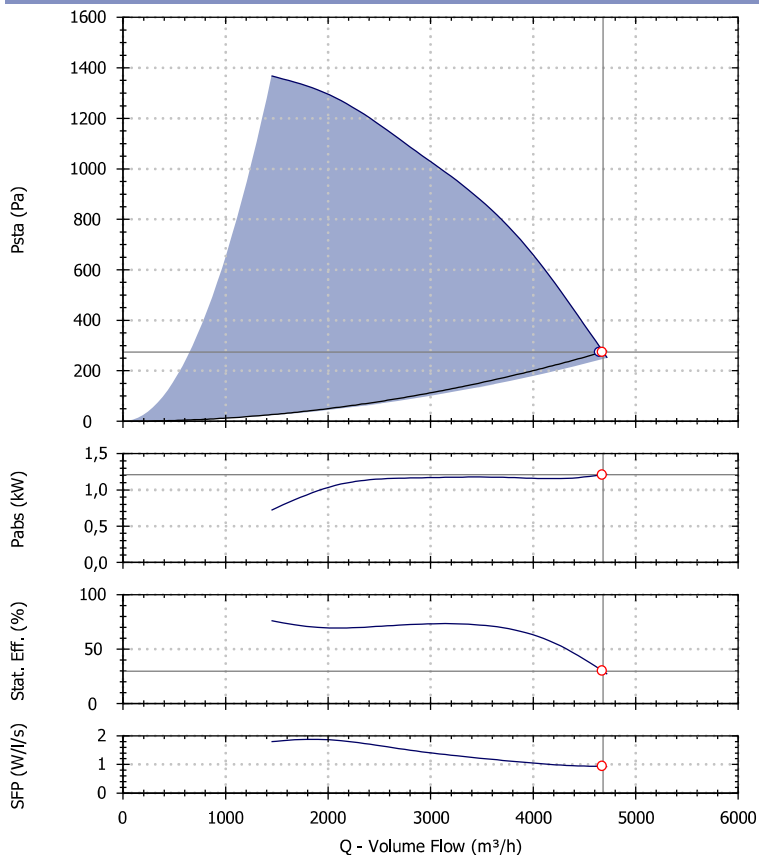

Performances refers to Maico Italia measures and may vary according to the installation type.

Sound Performance

Hz	63	125	250	500	1k	2k	4k	8k	Overall
Lw	76	78	76	77	73	68	60	52	83
Lw(A)	50	62	67	74	73	69	61	51	78
LpA @ 3m	29	41	47	53	52	49	40	30	57

Sounds spectra refers to Maico Italia measures performed in our laboratories. The values provided are just indicative of the situation and Maico Italia declines every responsibility in case different levels measured by our customers as the installation types and the environmental variables may increase/decrease these values.

Drawing and Dimensions - PR-AC 312 T

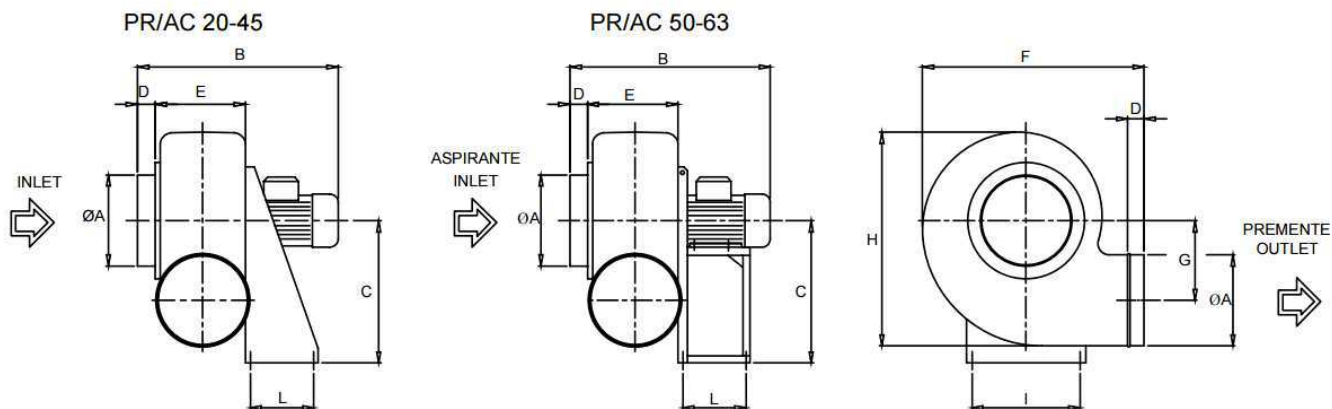

Key	B	C	D	E	F	G	H	I	kg	L	M	N	O	OA
Value [mm]	500	410	40	200	560	240	670	315	31	150	120	300	170	250

Drawings are indicative of the size of the selected fan. These dimensions may vary, even without any explicit advice. To have more accurate information contact your local agency.

Electric Wire Connections

